

INFINITY SLIM BIDIRECTIONAL SUSPENDED

FICHA TÉCNICA · FICHE TECHNIQUE · HOJA DE DATOS

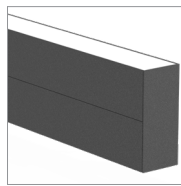
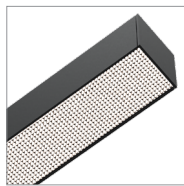
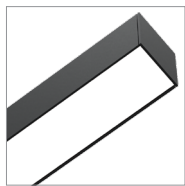
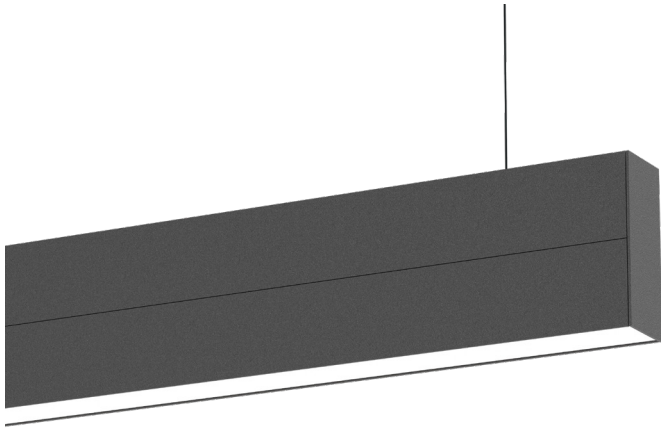

EN

Infinity Slim Bidirectional Suspended · Description

Bidirectional suspended luminaire in aluminium profile. Equipped with LED PCB, it can be equipped with two types of LED, a low flux and a normal flux.

PT

Infinity Slim Bidirecional Suspensa · Descrição

Luminária suspensa bidireccional em perfil de alumínio. Equipada com PCB de LED, podendo ser equipada com dois tipos de led um de baixo fluxo e um de fluxo normal.

FR

Infinity Slim Bidirectionnel Suspendu · Description

Suspension bidirectionnelle en profilé d'aluminium. Equipée de LED PCB, elle peut être équipée de deux types de LED, une à faible flux et une à flux normal.

ES

Infinity Slim Bidireccional Suspendida · Descripción

Luminaria de suspensión bidireccional en perfil de aluminio. Equipada con PCB de LED, puede ser equipada con dos tipos de LED, uno de bajo flujo y otro de flujo normal.



POWERED BY **TRIDONIC** LED BY **OSRAM**

AVAILABLE MEASUREMENTS / MEDIDAS DISPONÍVEIS

MESURES DISPONIBLES / MEDIDAS DISPONIBLES

LED

L1 (mm)	w	Lumens
568	36	4900
708	40	5400
848	46	6600
988	56	7800
1128	60	8600
1268	70	9800
1408	74	11000
1548	84	12200
1688	90	13000
1828	96	14200
1968	102	15200
2108	114	16400
2248	120	17400
2388	128	18600
2528	140	19400
2668	146	20600
2808	154	21800
2948	160	22800
3090	168	23800

TECHNICAL DRAWING / DESENHO TÉCNICO

DESSIN TECHNIQUE / DIBUJO TÉCNICO

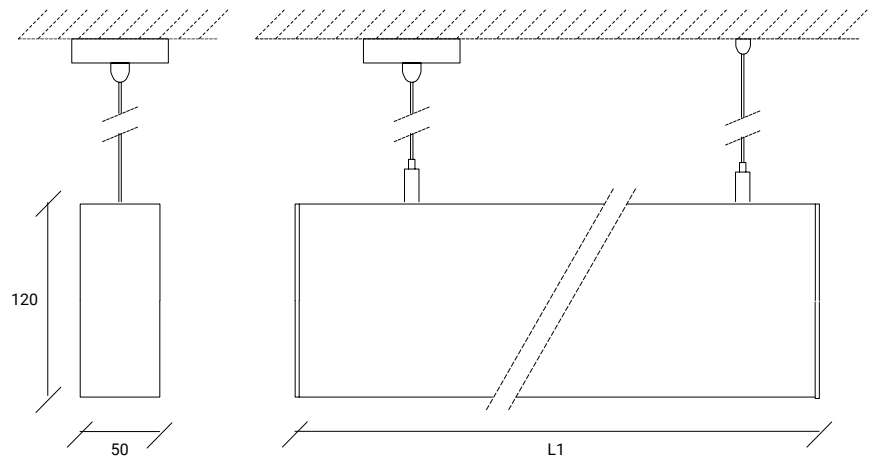

Other dimensions on request

Outras dimensões sob consulta.

Autres dimensions sur demande

Otras dimensiones bajo pedido.

Possible to produce in a continuous line, under consultation.

Possibilidade de produção em linha contínua, sob orçamento.

Possibilité de production en ligne continue, sur demande.

Puede ser producido en línea continua, bajo pedido.

All information in this document is subject to change without notice. / Todas as informações disponibilizadas neste documento podem ser alteradas sem prévio aviso. /

Toutes les informations contenues dans ce document sont susceptibles d'être modifiées sans préavis. / Toda la información disponible en este documento está sujeta a cambios sin previo aviso.

Mod. 052

TECHNICAL CHARACTERISTICS / CARACTERÍSTICAS TÉCNICAS / CARACTÉRISTIQUES TECHNIQUES

COLOUR STABILITY / ESTABILIDADE DA COR
 STABILITÉ DES COULEURS / ESTABILIDAD DE COLOR

3 SDCM

DIFFUSER / DIFUSOR / DIFFUSEUR

Satin Polycarbonate / Policarbonato Satinado / Polycarbonate satiné

UGR <19 Transparent Microprismatic / Microprismático Transparente /
 Microprismatique Transparent

LIGHT DISTRIBUTION / DISTRIBUIÇÃO DE LUZ
 DISTRIBUTION DE LA LUMIÈRE / DISTRIBUCIÓN DE LA LUZ

Direct / Indirect
 Direta / Indireta
 Directe / Indirecte
 Directa / Indirecta

OPTIONS / OPÇÕES / OPTIONS / OPCIONES

Control / Controlo / Regulation / Regulação /
 Contrôle / Control Règlement / Reglamento

DALI 1-10V

PHOTOBIOLOGICAL RISK / RISCO FOTOBIOLOGICO
 RISQUE PHOTOBIOLOGIQUE / RIESGO FOTOBIOLOGICO

Certification RG1 - Photobiological Risk 1 (RG0 on request)
 Certificação RG1 - Risco Fotobiológico 1 (RG0 Sob Pedido)
 Certification RG1 - Risque photobiologique 1 (RG0 sur demande)
 Certificación RG1 - Riesgo Fotobiológico 1 (RG0 Bajo Pedido)

MOUNTING / MONTAGEM / MONTAGE / MONTAJE

Suspended / Suspensa / Suspendu / Suspendido

LED LIFETIME / VIDA ÚTIL DO LED
 DURÉE DE VIE DES LED / VIDA ÚTIL DEL LED

50.000 hours / horas / heures
 L80F10 (Ta=25°C)

LED MODULE / MÓDULO LED / MODULE LED

2700k / 3000k / 4000k / 5000k / 6500k

Other colour temperatures on request.

Outras temperaturas de cor sob consulta.
 Autres températures de couleur sur demande.
 Otras temperaturas de color bajo pedido.

PHOTOMETRY / FOTOMETRIA / PHOTOMETRIE / FOTOMETRÍA

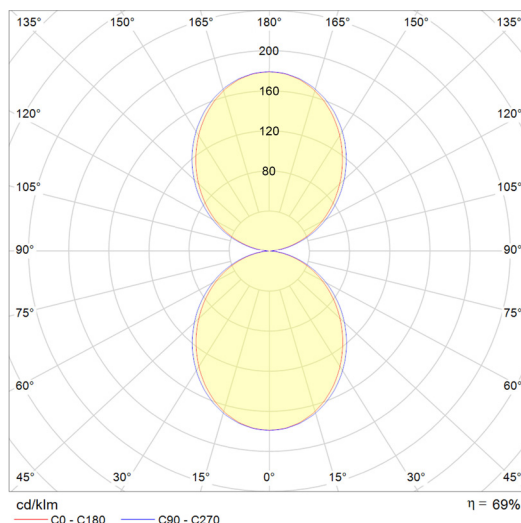

IP 40 IRC > 80

FINISHES / ACABAMENTO / FINITION / ACABADO



Corten steel and other RAL colours on request.

Aço Corten e outras cores RAL sob consulta.
 Acier Corten et autres couleurs RAL sur demande.
 Acero corten y otros colores RAL bajo pedido.

* Matte Textured / Mate Texturado / Mat Texturé / Textura Mate

All information in this document is subject to change without notice. / Todas as informações disponibilizadas neste documento podem ser alteradas sem prévio aviso. /
 Toutes les informations contenues dans ce document sont susceptibles d'être modifiées sans préavis. / Toda la información disponible en este documento está sujeta a cambios sin previo aviso.

COMPONENTS / COMPONENTES / COMPOSANTS

SUSPENSION BASE / BASE DE SUSPENSÃO
 BASE DE LA SUSPENSION / BASE DE SUSPENSION

Single Surface Mounted Base (option 1)

Base de fixação simples saliente (opção 1)
 Base simple pour montage en surface (option 1)
 Base de fijación simple superficie (opción 1)



Recessed Fixation Base (option 2)

Base de fixação encastrada (opção 2)
 Base de fixation encastrée (option 2)
 Base de fijación empotrada (opción 2)



Square Protruding Mounting Base (option 3)

Base de montagem quadrada saliente (opção 3)
 Base de montage carrée en saillie (option 3)
 Base de montaje cuadrada saliente (opción 3)



Possible Finishes / Acabamentos Possíveis

Finitions Possibles/ Posibles Acabados

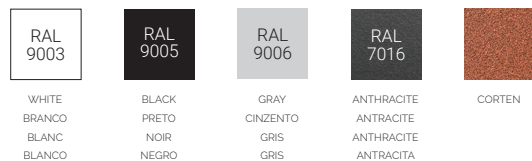

SUSPENSION CABLE / CABO DE SUSPENSÃO
 CÂBLE DE SUSPENSION / CABLE DE SUSPENSION

Available Measurements / Medidas Disponíveis
 Mesures Disponibles / Medidas Disponibles



1,2m - 2m - 3m - 5m

POWER CABLES / CABOS DE ALIMENTAÇÃO
 CÂBLES D'ALIMENTATION / CABLES DE ALIMENTACION

Should maintain the length selected previously
 for the steel cables

Deverão manter o comprimento selecionado
 anteriormente para os cabos de aço



Doivent conserver la longueur choisie
 précédemment pour les câbles d'acier.

Deben mantener la longitud seleccionada
 previamente para los cables de acero

TOPS / TOPOS

Possible Finishes / Acabamentos Possíveis

Finitions Possibles/ Posibles Acabados



Corten steel and other RAL colours on request.

Aço Corten e outras cores RAL sob consulta.
 Acier Corten et autres couleurs RAL sur demande.
 Acero corten y otros colores RAL bajo pedido.

* Matte Textured / Mate Texturado / Mat Texturé / Textura Mate

COMPONENTS FOR CONTINUOUS LINES ONLY

COMPONENTES SOMENTE PARA LINHAS CONTÍNUAS
 COMPOSANTS POUR LES LIGNES CONTINUES UNIQUEMENT
 COMPONENTES SÓLO PARA LÍNEAS CONTINUAS

Set of Connections / Conjunto de Uniões /

Ensemble d'unions / Conjunto de Uniones

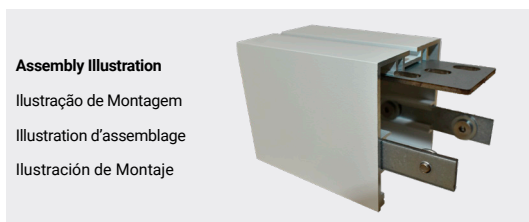
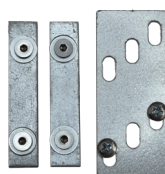

Assembly Illustration

Ilustração de Montagem

Illustration d'assemblage

Ilustración de Montaje

Quick Connectors / Ligadores Rápidos

Connecteurs Rapides / Conectores Rápidos

